

# Dragon-PA-S3

Date: 31.03.2003 09:43:26

HIDB electronic

V5 12AX7EH  
V6-9 selected EL34EH

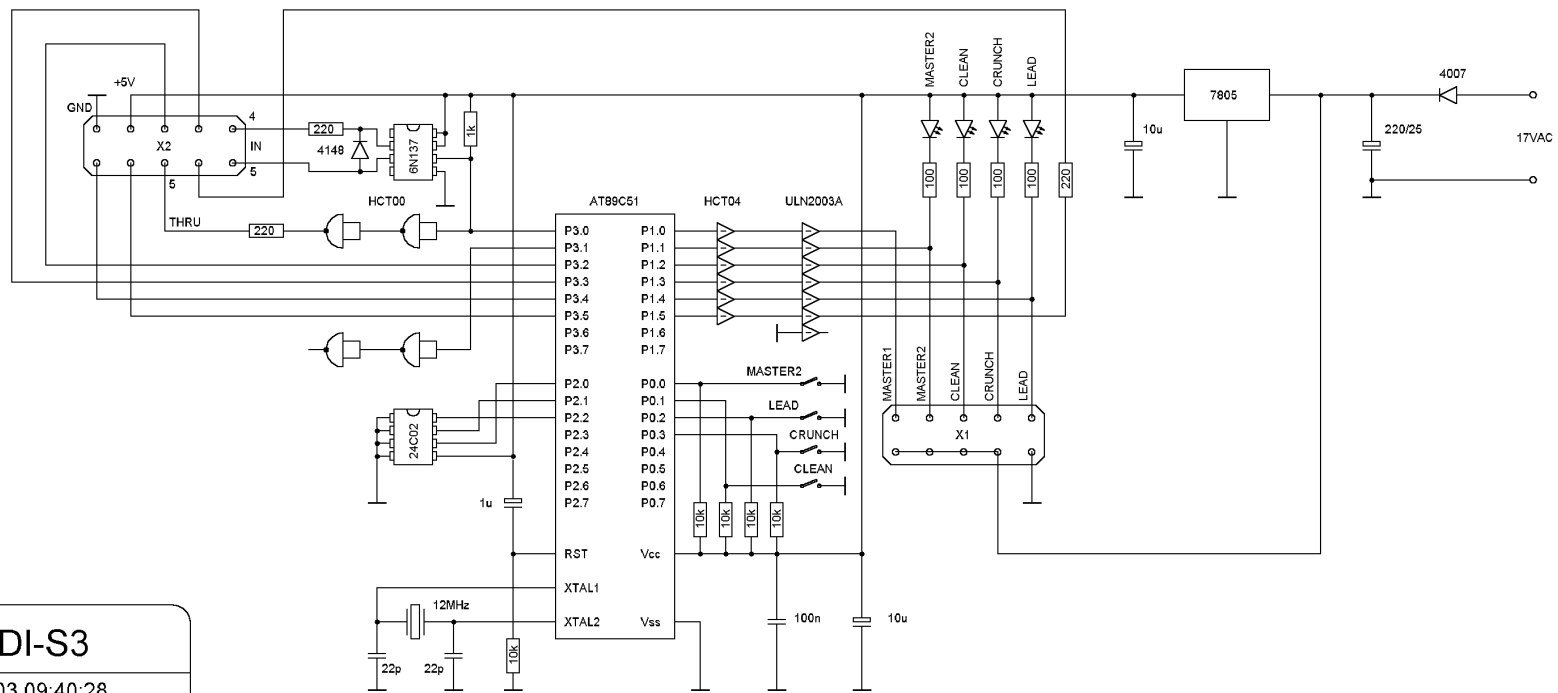
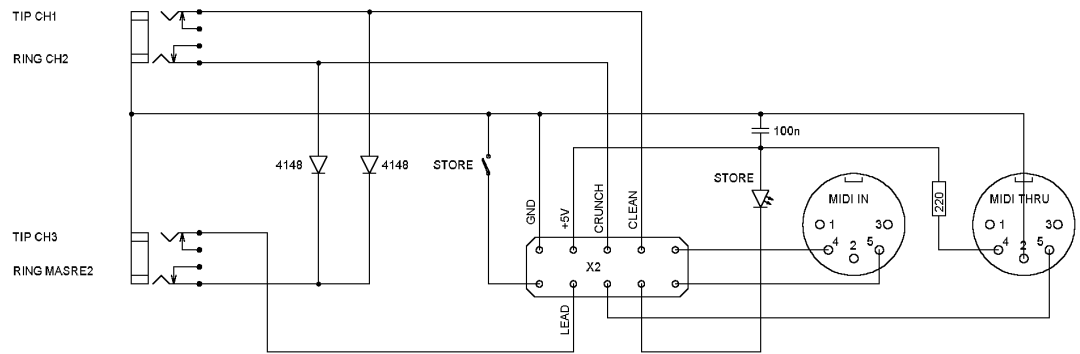

# Dragon-MIDI-S3

Date: 31.03.2003 09:40:28

HIDB electronic



# Dragon-DIV-B3

Draw: 31.03.2003 09:39:40

HDB electronic

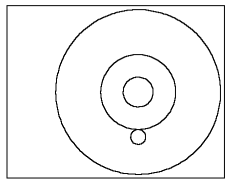
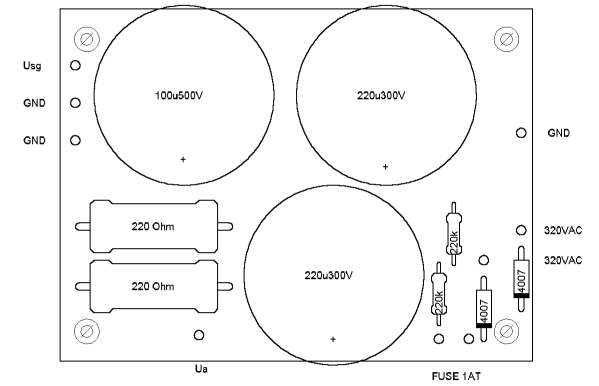
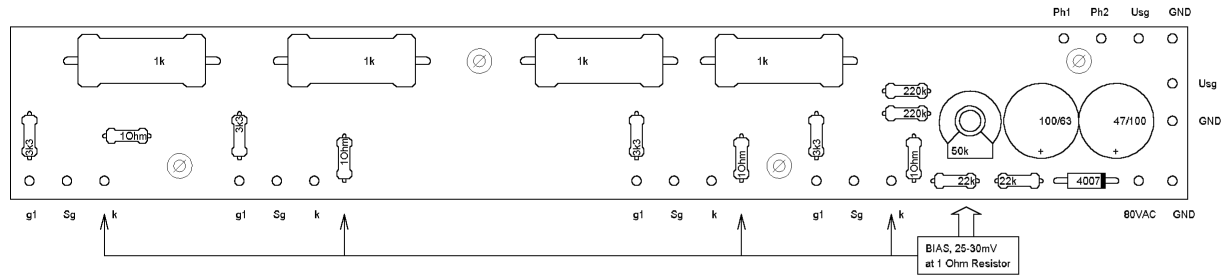

IMPEDANCE SELECT

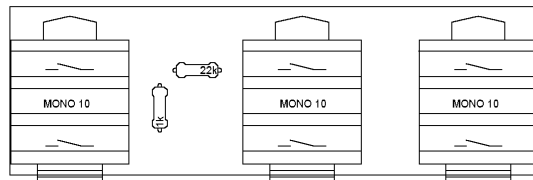

LINE OUT

SPEAKER

SPEAKER

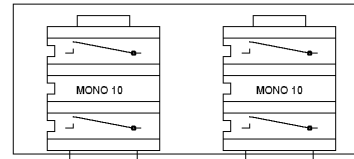

SEND

EFF LOOP

RET

# Dragon-MIDI-B3

Draw: 31.03.2003 09:39:14

HDB electronic

IN4 IN5  
 CH1 LED  
 CH2 THRU5  
 +5V CH3  
 GND SAVE

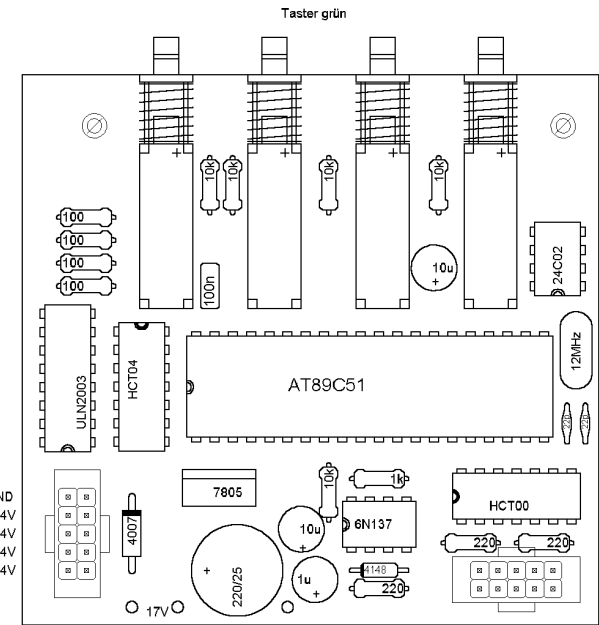
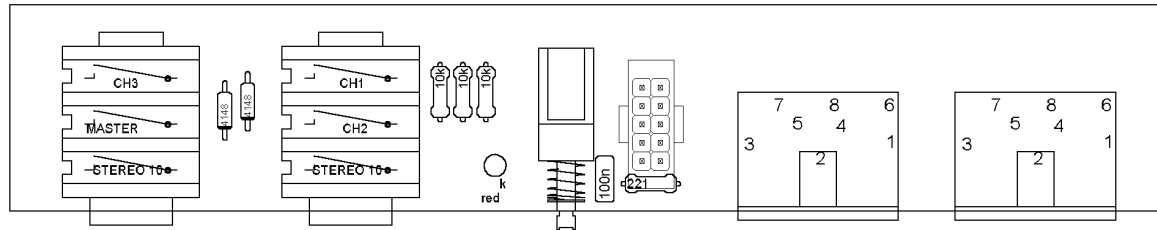

LEAD GND  
 CHRUNCH +24V  
 CLEAN +24V  
 MASTER2 +24V  
 MASTER1 +24V

GND  
 +5V  
 CH2  
 CH1  
 LED  
 IN5  
 IN4