

Dragon-PA-S2
 Date: 10.04.2003 10:43:24
 HIDB electronic

V5 12AX7EH
 V6-9 selected EL34EH

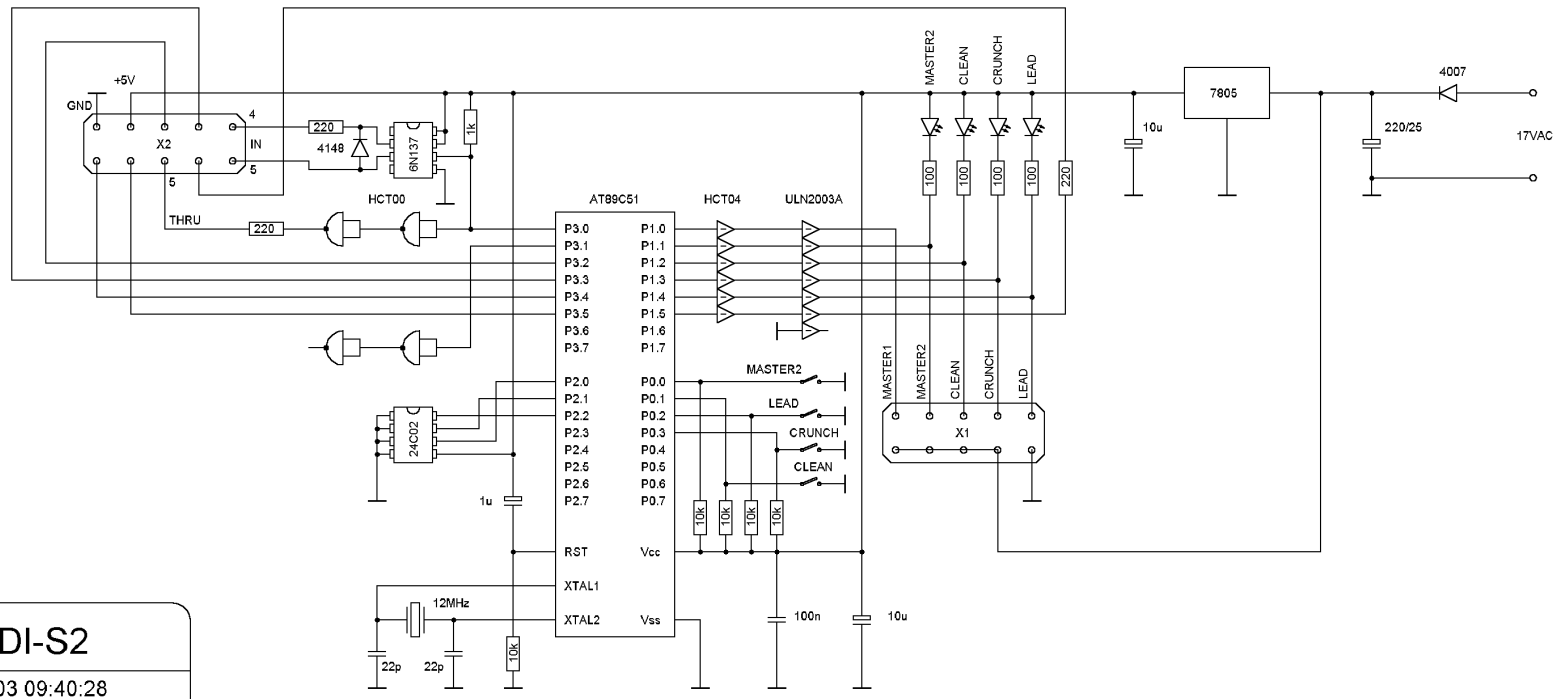

Dragon-MIDI-S2
 Date: 31.03.2003 09:40:28
 HIDB electronic

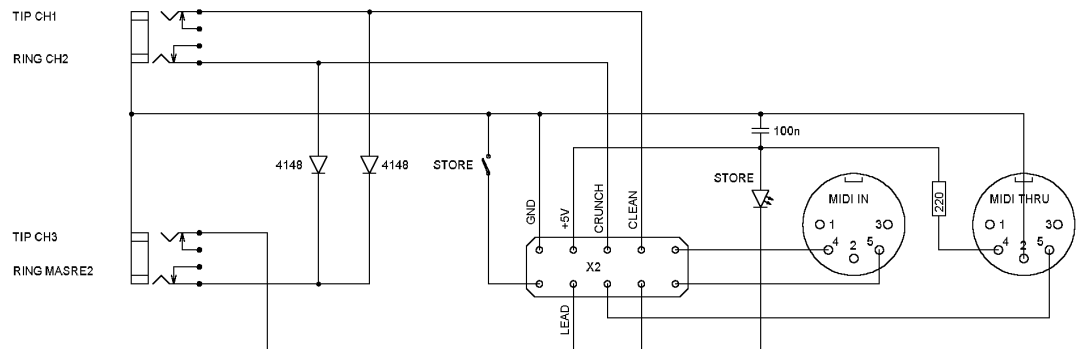
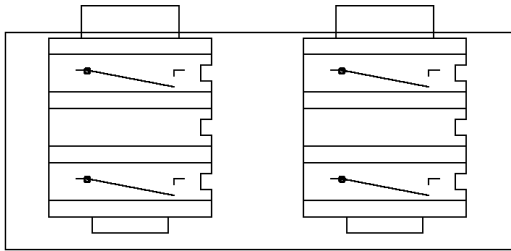

Dragon-DIV-B2
 Draw: 11.04.2003 07:46:48
 HDB electronic

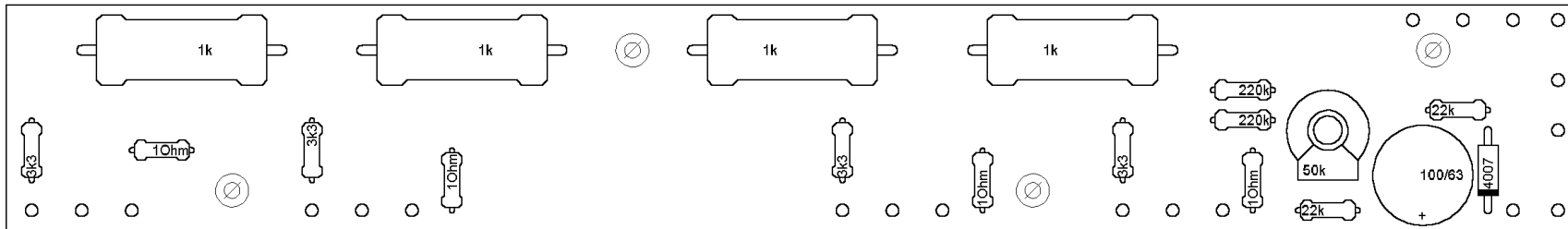
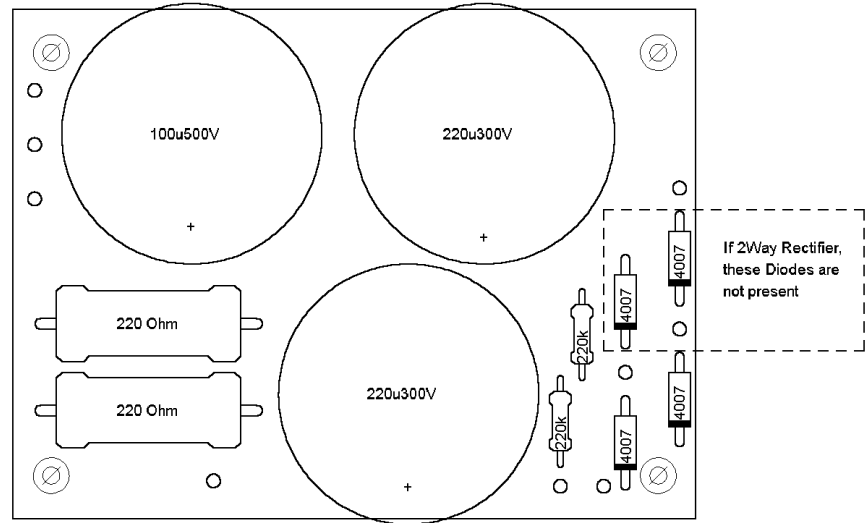

Dragon-MIDI-B2

Draw: 31.03.2003 09:39:14

HDB electronic

IN4 IN5
 CH1 LED
 CH2 THRU5
 +5V CH3
 GND SAVE

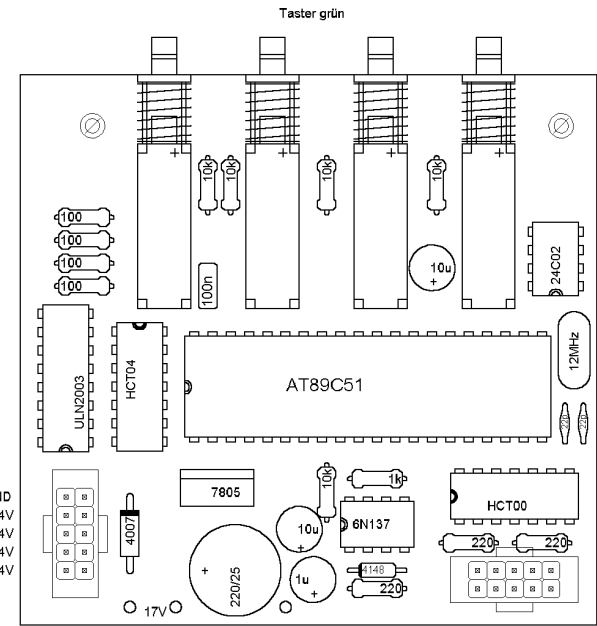
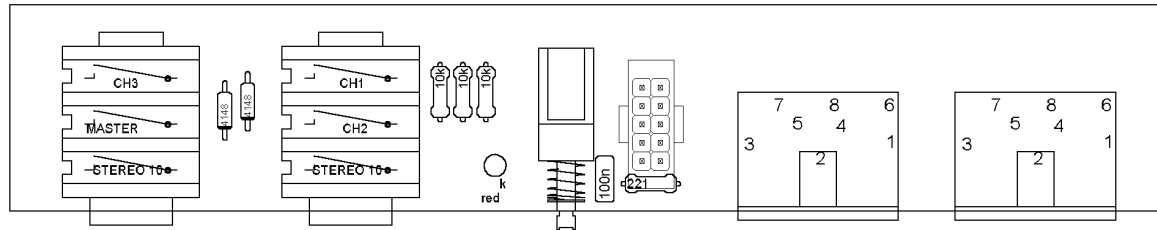

LEAD GND
 CHRUNCH +24V
 CLEAN +24V
 MASTER2 +24V
 MASTER1 +24V

GND
 +5V
 CH2
 CH1
 CH3
 LED
 IN5
 IN4
 THRU5